



# MAQUETTE EXPERIMENTATION SYSTEME D'ENGRENAGES

## NOMENCLATURE

- 2 x  Brique en barre 1X12, Ø4,9    1 x  Brique plate 2X3 -    1 x  Connecteur
- 1 x  Bague    2 x  Axe    1 x  Volant    2 x  Engrenage 40 dents

## DÉROULEMENT

### Etape 1

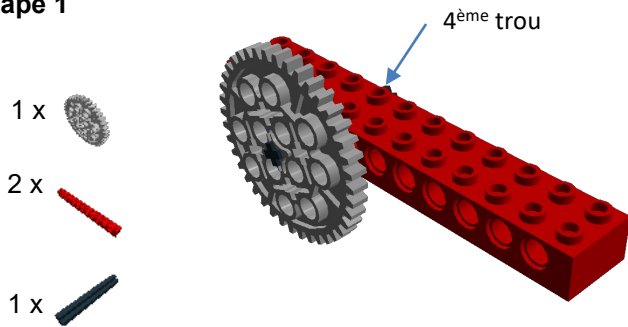



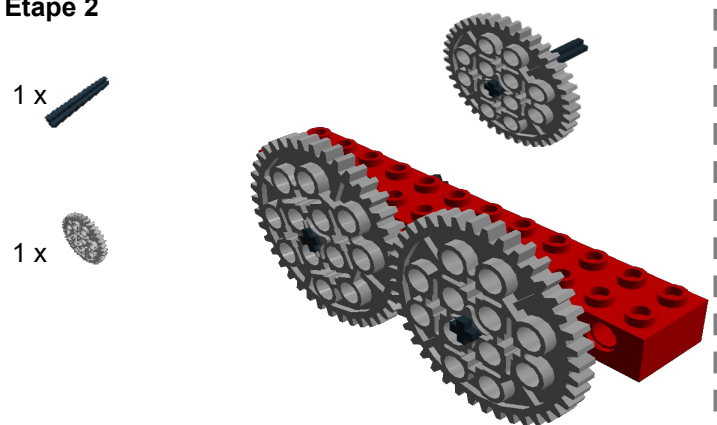

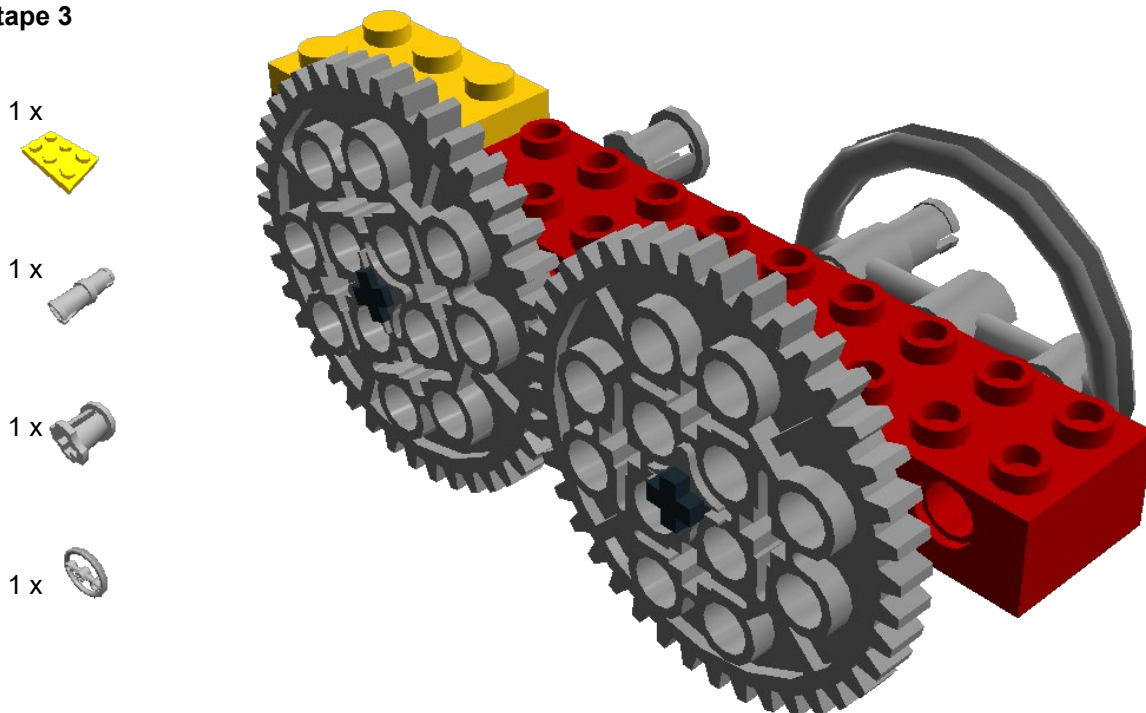

### Etape 2



### Etape 3



## NOMENCLATURE DES ÉLÉMENTS SUPPLÉMENTAIRES POSSIBLES POUR RELEVER LES DÉFIS.

- 1 x  CONNECTEUR NOIR    2 x  AXE    3 x  BAGUE
- 1 x  MANIVELLE    2 x  ROUE DENTÉE 8 dents    1 x  ROUE DENTÉE 24 dents

# MAQUETTE EXPERIMENTATION SYSTEME D'ENGRENAGES

## NOMENCLATURE

- 2 x  Brique en barre 1X12, Ø4,9    1 x  Brique plate 2X3 -    1 x  Connecteur
- 1 x  Bague    2 x  Axe    1 x  Volant    2 x  Engrenage 40 dents

## DÉROULEMENT

### Etape 1

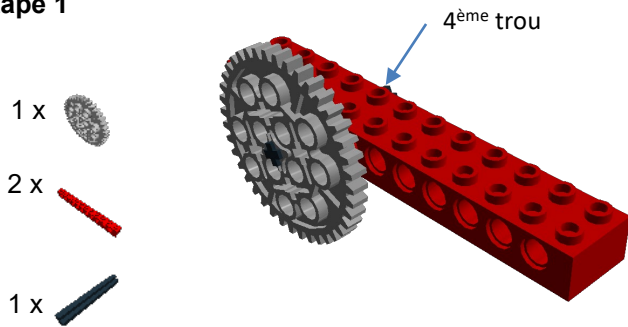



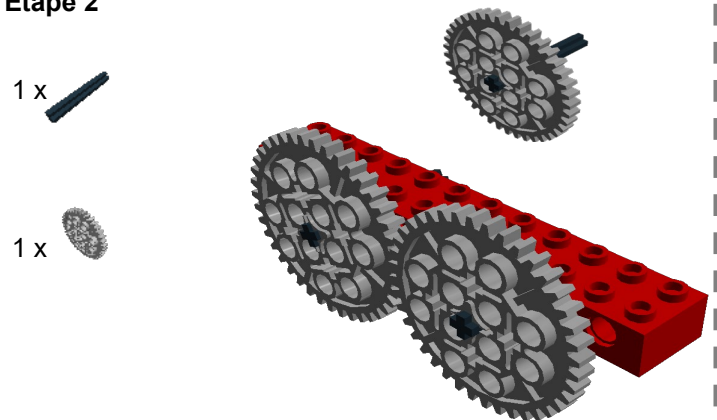

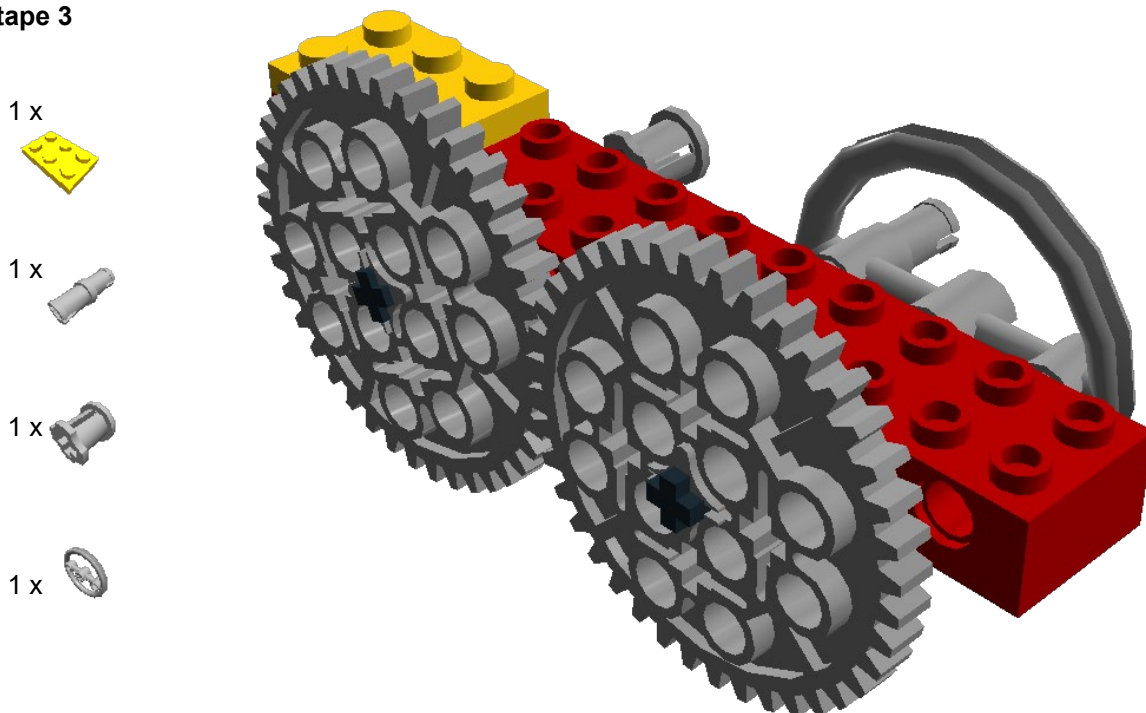

### Etape 2



### Etape 3



## NOMENCLATURE DES ÉLÉMENTS SUPPLÉMENTAIRES POSSIBLES POUR RELEVER LES DÉFIS.

- 1 x  CONNECTEUR NOIR    2 x  AXE    3 x  BAGUE
- 1 x  MANIVELLE    2 x  ROUE DENTÉE 8 dents    1 x  ROUE DENTÉE 24 dents